



Operation Manual

Troll® Drywall Cart & Spanning Platform

WARNING: Read and become familiar with this manual BEFORE operating unit.
Failure to do so could result in serious property damage and or serious bodily injury.

contents

Troll® Drywall Cart

Warning & Instructional Information	3
Components & Product Specifications	4
Care & Maintenance	4
Assembly & Use	5
Parts Index	7

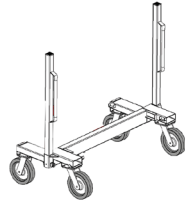

Troll® Drywall Cart Spanning Platform

Components	8
Assembly & Use	9

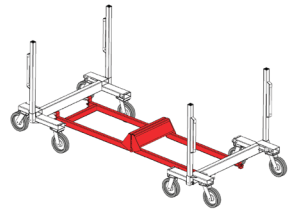

WARNING!

READ ALL SAFETY WARNINGS AND ALL INSTRUCTIONS BEFORE OPERATING THIS EQUIPMENT. FAILURE TO UNDERSTAND AND FOLLOW THE WARNINGS AND INSTRUCTIONS MAY RESULT IN MISUSE OR FAILURE OF THE EQUIPMENT. MISUSE OR FAILURE OF THE EQUIPMENT WHILE THE CART IS LOADED CAN RESULT IN OVERTURNING THE CART AND LOAD, POTENTIALLY RESULTING IN SERIOUS PROPERTY DAMAGE AND/OR SERIOUS BODILY INJURY.

- It shall be the responsibility of the owner of the Troll® Cart to keep the product properly maintained.
- As with any material handling equipment, **ALWAYS WEAR APPROPRIATE PERSONAL PROTECTIVE EQUIPMENT** when operating the Troll® Cart. Failure to do so could result in serious bodily injury.
- **DO NOT ATTEMPT TO USE YOUR TROLL® CART IF ANY PART IS MISSING, DAMAGED OR WORN. ORDER A REPLACEMENT PART IMMEDIATELY.** Using a Troll® Cart with missing, damaged or worn components can result in failure of the unit and possibly serious property damage and/or serious bodily injury.
- **THE WEIGHT CAPACITY OF THE TROLL® CART IS 3,000 LBS. (1,360 KG). DO NOT LOAD THE UNIT BEYOND THIS LIMIT.** Failure to follow this warning can result in damage to the cart contributing to a sudden failure of the cart and possibly serious property damage and/or serious bodily injury.
- **THE LOAD SIZE CAPACITY OF THE TROLL® CART IS 4' (1.2m) FROM THE LOAD SUPPORT FRAME. DO NOT LOAD THE UNIT BEYOND THIS LIMIT OR WITH MATERIALS THAT EXCEED THIS LIMIT.** Failure to follow this warning can result in destabilising of the loaded cart. Such destabilising of the loaded cart can result in failure of the cart and/or overturning of the cart and possibly severe property damage and/or serious bodily injury.
- **OPERATE THE TROLL® CART ONLY ON HARD, FLAT, LEVEL SURFACES FREE OF OBSTRUCTIONS, DEBRIS, CLUTTER, PITS, HOLES OR OPENINGS.** Failure to follow this warning can result in tipping the cart and load possibly resulting in serious property damage and/or serious bodily injury.
- **WHEN MOVING A LOADED TROLL® CART, ALWAYS PUSH THE CART. NEVER PULL THE LOADED CART TOWARD THE OPERATOR. WHEN MOVING ANY LOADED CART, UNFORESEEN AND UNANTICIPATED CIRCUMSTANCES CAN ARISE WHICH CAN RESULT IN UNANTICIPATED MOTION AND/OR DESTABILISING OF THE LOADED CART.** Such unanticipated motion and/or destabilising of the loaded cart can result in failure of the cart and/or overturning of the load and possibly severe property damage and/or serious bodily injury.
- When moving a loaded Troll® Cart, **ALWAYS** keep nearby personnel aware of and clear of the cart's motion to avoid being struck and possibly injured by the loaded cart or load.
- The Troll® Cart is made of steel which conducts electricity. **KEEP THE UNIT AWAY FROM LIVE ELECTRICAL WIRES.** Failure to do so could result in electrocution.
- Use only Intex authorised replacement parts. Installation of other parts can compromise the safe design of the Troll® Cart and may cause failure of the unit possibly resulting in serious property damage and/or serious bodily injury. Use of non-manufacturer authorised replacement parts will void all warranties.

TROLL® CART COMPONENTS & SPECIFICATIONS

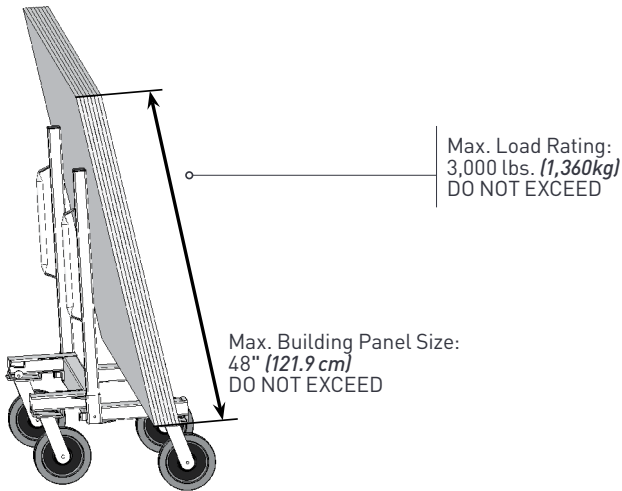
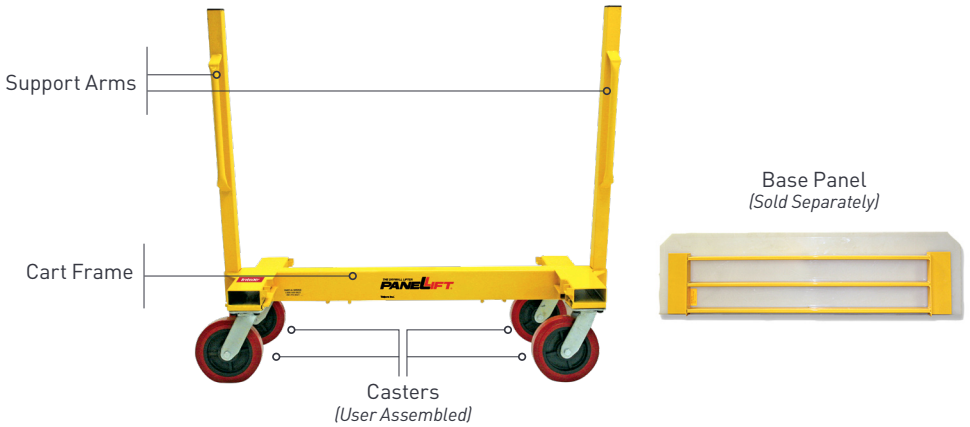

CARE & MAINTENANCE

Inspect FREQUENTLY (at least daily and before each use):

- Inspect casters FREQUENTLY (at least daily and before each use) for proper operation of all rollers and bearings. For casters equipped with brakes and swivel locks, check these for proper operation.
- Inspect casters FREQUENTLY (at least daily and before each use) for secure attachment to the cart frame. Tighten all caster fasteners securely if necessary.
- Inspect the latch pins that secure the upright arms in the working position for proper operation. Repair or replace when necessary to maintain proper function.
- Occasionally oil the caster bearings.
- Take reasonable care to avoid damaging the Troll® Cart when transporting or using it.

ASSEMBLY & USE

1. For initial assembly fasten all casters securely with four bolts per caster.

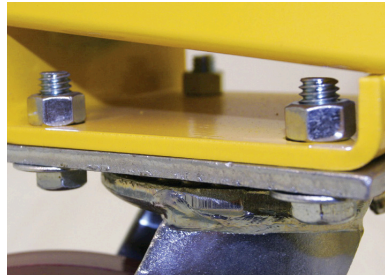

2. Press the release tab to remove the upright arms from the storage and transport position.

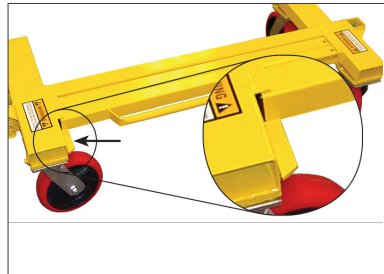

3. Lock the support arms in the upright position when loading building boards and similarly configured materials.

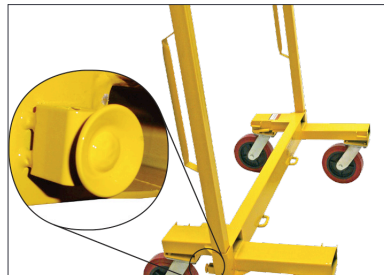

ASSEMBLY & USE

4. As with all carts, when moving the Troll® Cart while loaded, ALWAYS push the loaded cart away from the operator. NEVER pull the loaded cart toward the operator.

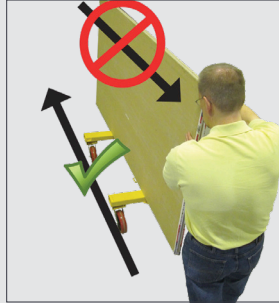

5. The support arms can be positioned to configure the Troll® Cart for use as a flatbed cart.



6. With the arms locked in the storage and transport position, the Troll® Cart can be conveniently handled for loading and compact transportation.



PARTS INDEX



Part #	Name
PLC01	Upright Storage Latch
PLC02	Upright Latch Assembly (Pull Pin)
PLC03	Upright Tube
PLC04	Swivel 8" Caster
PLC05	Upright End Cap
PLC14	Swivel-Locking / Braking Caster



TROLL® SPANNING PLATFORM COMPONENTS

Troll® Spanning Platform End #1 (CD272)

2 x Troll® Carts (CD136)
Sold Separately

Troll® Spanning Platform End #2 (CD272)



ASSEMBLY & USE



1. Mount each half of the Troll® Spanning Platform on the Troll® Carts

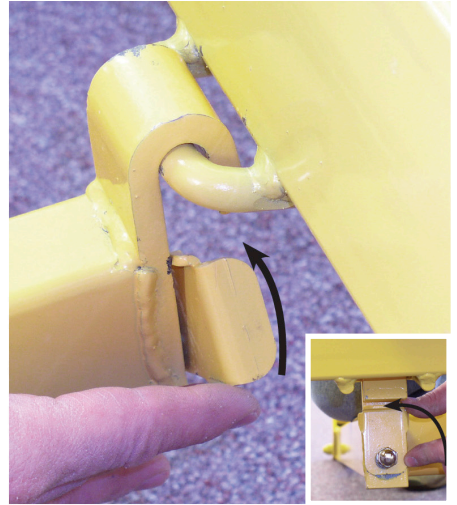

2. Close the Frame Catch. **CAUTION:** Never use the Troll® Spanning Platform without closing these catches. If the catches are not closed the Troll® Spanning Platform may detach from the cart possibly resulting in property damage or bodily injury.

ASSEMBLY & USE

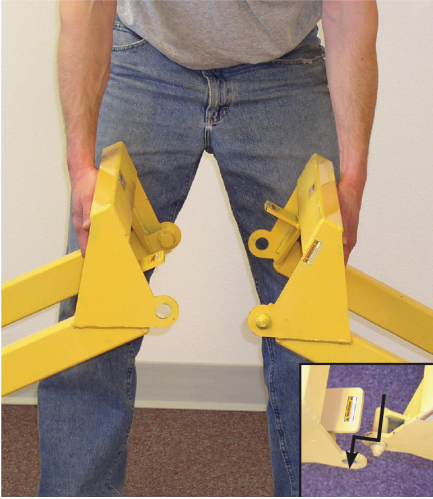

3. Bring the two halves together. Align and simultaneously insert the pins on each half into the corresponding holes on the other half.



4. Lower the assembled halves to the locked position. **CAUTION:** Keep hands and fingers clear of pinch points.

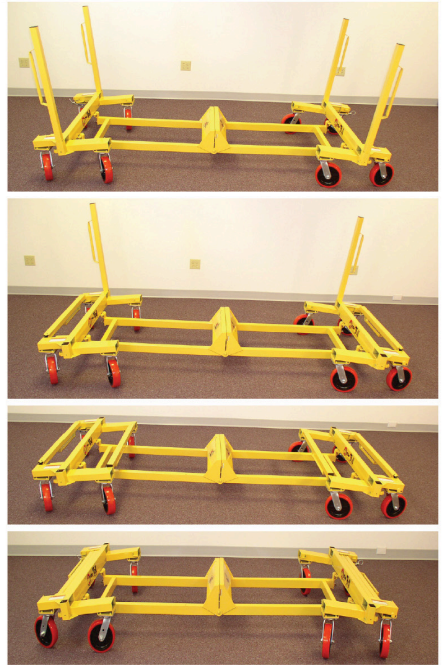

The support arms can be installed in a wide variety of positions depending on the support needs of the load being carried.

WARNING!
**Load rating of assembled
system: 4,000 lbs. (1814 kg)**
DO NOT EXCEED



intexinternational.com

Troll® is a registered Trademark of Intex International.
Distributed in Australia & New Zealand by Intex International.
The information contained in this brochure was correct at the time of printing. E&OE